

Linear

LINI-S XL R014

Fixture Guide

KKDÖ

Indoor | Surface | Output up to 772lm/m (235lm/ft)



Key applications

- ✓ Architectural detail
- ✓ Cove lighting
- ✓ Direct lighting
- ✓ Interior
- ✓ Mirror back lighting
- ✓ Retail display
- ✓ Shelving display

Key features

- ✓ Custom lengths
- ✓ Constant Voltage (CV)
- ✓ Diffusion: homogenous
- ✓ Direct view
- ✓ Extensive CCT range
- ✓ IP40 dry area

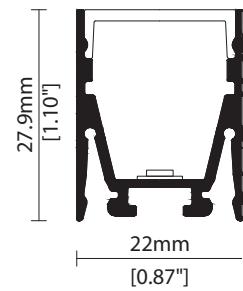

MOUNTING METHODS



KKCP-11 Concealed clip

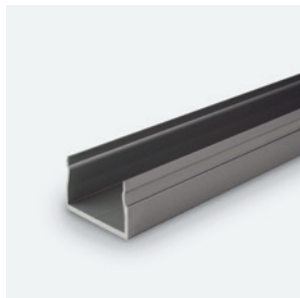

KKCR-01-1000 Cable raceway (1000mm)
KKCR-01-2000 Cable raceway (2000mm)
KKCR-01-3000 Cable raceway (3000mm)



KKJT-02 Joining bar

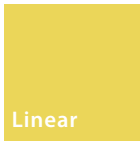

LINI-S XL R014

Specification sheet



Dimensions	H28/W22/L94-2011mm (H1.1/W0.87/L3.70-79.17in)
PCB Cut-point	41.7mm increment/2000mm max (1.64in increment/78.74in max)
LED Pitch	6.95mm-144LED/m (0.27in - 44LED/ft)
Chip	s-line k-line
Cover/Optics	Clear (50°)/Diffused (120°)
CCT	s-line: 1900K/2100K/2300K/2500K/2700K/3000K/3500K/4000K/5000K Single colours: Red/Green/Blue/Orange/Amber k-line: 1900K/2100K/2300K/2500K/2700K/3000K/3500K/4000K/5000K
LED binning	s-line: 2-step MacAdam ellipse k-line: 3-step MacAdam ellipse
CRI	≥92
Lifetime	50,000 hours @ 25°C (50,000 hours @ 77°F)
Operating temp	T _a = -25 to 50°C (T _c max = 76°C) T _a = -13 to 122°F (T _c max = 169°F)
IP Rating	IP40
Finish	Silver anodised
Mounting	Surface mounting via concealed clips
Power feed	Hardwire tails or male/female connectors
Control	0-10V/1-10V/DMX/DALI



LED Grading Key

Exclusive Grade

s s-line*	*KKDC tuned CCT range
2-step CCT range	

Base Grade

k k-line	3-step commercial range Energy Star CCTs
------------------------	---

Power consumption	Supply voltage	Supply current
14W/m (4.27W/ft)	24V DC	0.58A/m (0.18A/ft)

Performance Data (3000K)

	R1	R2	R3	R4	R5	R6	R7	R8	R9	R10	R11	R12	R13	R14
k-line	93	96	97	91	92	94	92	83	64	91	91	73	94	98

	Clear Cover	Diffused Cover	CRI	R9	Rf	Rg
s-line	772lm/m (235lm/ft) 55.1lm/W	519lm/m (158lm/ft) 37.1lm/W	93	65	-	-
k-line	728lm/m (222lm/ft) 52lm/W	490lm/m (149lm/ft) 35lm/W	92	64	-	-

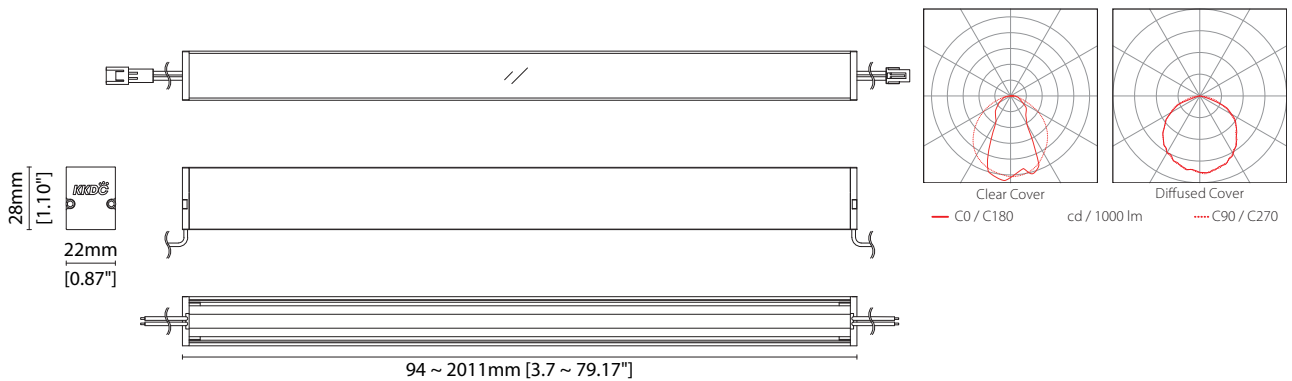

Data derived from independent UKAS/IESNA LM-79-08 accredited testing of production samples.

LINI-S XL R014

Code Table



FIXTURE

Model	Finish	Cover ¹	Grade ²	LED	Colour (CCT)	Length Availability ³	IP	Cable Length	Power Feed ⁴	Input						
LINI-S XL	SX Silver Anodised	SA Clear Diffused	B C	s k	R014	R014	m 94-2011mm 83.3mm increments i 3.71-79.17in 3.28in increments (Specify length code OR total run length)	IP40	40	300mm/ 11.81"	0300	Single no sheath tail Double no sheath tail Single no sheath IP20 connector Double no sheath IP20 connector	S00X D00X S20X D20X	DC 24V	g	
					1900K	19										
					2100K	21										
					2300K	23										
					2500K	25										
					2700K	27										
					3000K	30										
					3500K	35										
					4000K	40										
					5000K	50										
					RED	RED										s-only
					GREEN	GRN										
					BLUE	BLU										
ORANGE	ORN															
AMBER	AMB															

¹ Refer to **Cover/Lens options** on **Options** pages

² Refer to **LED Grading Key** on **Specification sheet** page

³ Refer to **Length Availability List** or enter total run length instead of length code

⁴ Refer to **Power Feed Options** on **Options** pages

Code Example:

SX	-	SA	-	C	-	s	-	R014	-	35	-	m	-	511	-	40	-	0300	-	D00X	-	g
LINI-S XL		Silver Anodised		Diffused				R014		3500K		511mm		IP40		300mm/11.81"		Double no sheath tail		DC 24V		

ACCESSORIES

Mounting Accessories

KKCP-11	Concealed Clip
KKCR-01-1000	1000mm/39.37" Cable Raceway
KKCR-01-2000	2000mm/78.74" Cable Raceway
KKCR-01-3000	3000mm/118.11" Cable Raceway
KKJT-02	Joining Bar

Connection Accessories

KKCN-01	2 PIN male & female 50mm/1.97" pair
KKCN-03	2 PIN male & female 300mm/11.81" pair
KKCN-06	2 PIN 300mm/11.81" extension lead

* Refer to **Power feed** on **Accessories** pages

PSU/Driver

0-10V/1-10V/DALI/DMX

* Refer to **Driver/PSU Options** page for details or provide requirement and KKDC to offer the suitable option

* Refer to **Mounting accessories** on **Accessories** pages

LED ENGINE VARIANTS (LED STRIP TYPE)

Colour	LED	Lumen/m	Lumen/ft	W/m	W/ft	Spec Doc	Length	Increment
Single CCT	R007	423	129	7	2.13	LINI-S XL R007	94-2011mm/3.71-79.17in	41.7mm/1.64in
	R014	772	235	14	4.27	LINI-S XL R014	94-2011mm/3.71-79.17in	41.7mm/1.64in
Warm Dim/Dynamic White	R020	1230	375	20	6.10	LINI-S XL R020	94-2011mm/3.71-79.17in	41.7mm/1.64in
	A040	3080	939	40	12.19	LINI-S XL A040	88.0-1511mm/3.46-59.49in	38.46mm/1.51in
	R207	423	129	16	4.88	LINI-S XL R207	94-2011mm/3.71-79.17in	41.7mm/1.64in
RGB	501	Red 85 Green 184 Blue 30 RGB 267	Red 26 Green 56 Blue 9 RGB 81	15.6	4.75	LINI-S XL RGB	94-2011mm/3.71-79.17in	41.7mm/1.64in
RGBW	R201	727	222	20	6.10	LINI-S XL RGBW	136-2011mm/5.35-79.17in	62.5mm/2.46in

* Performance data: A/s-line, clear cover, 3000K

LINI-S XL R014

Length Availability List



Length Code		Fixture Length ¹		LED Strip ²		End Cap Dimension ³		Wattage (W)	Output (lm)
Metric	Imperial(US)	Metric	Imperial(US)	Metric	Imperial(US)	Metric	Imperial(US)		3000K (Test Data)
m0094	i0004	94mm	3.71in	83mm	3.28in	6mm	0.24in	1.17	61
m0136	i0005	136mm	5.35in	125mm	4.92in	6mm	0.24in	1.75	91
m0178	i0007	178mm	6.99in	167mm	6.56in	6mm	0.24in	2.33	121
m0219	i0009	219mm	8.64in	208mm	8.20in	6mm	0.24in	2.92	152
m0261	i0010	261mm	10.28in	250mm	9.84in	6mm	0.24in	3.50	182
m0303	i0012	303mm	11.92in	292mm	11.48in	6mm	0.24in	4.08	212
m0344	i0014	344mm	13.56in	333mm	13.12in	6mm	0.24in	4.67	243
m0386	i0015	386mm	15.20in	375mm	14.76in	6mm	0.24in	5.25	273
m0428	i0017	428mm	16.84in	417mm	16.40in	6mm	0.24in	5.83	303
m0469	i0018	469mm	18.48in	458mm	18.04in	6mm	0.24in	6.42	334
m0511	i0020	511mm	20.12in	500mm	19.69in	6mm	0.24in	7.00	364
m0553	i0022	553mm	21.76in	542mm	21.33in	6mm	0.24in	7.58	394
m0594	i0023	594mm	23.40in	583mm	22.97in	6mm	0.24in	8.17	425
m0636	i0025	636mm	25.04in	625mm	24.61in	6mm	0.24in	8.75	455
m0678	i0027	678mm	26.68in	667mm	26.25in	6mm	0.24in	9.33	485
m0719	i0028	719mm	28.32in	708mm	27.89in	6mm	0.24in	9.92	516
m0761	i0030	761mm	29.96in	750mm	29.53in	6mm	0.24in	10.50	546
m0803	i0032	803mm	31.60in	792mm	31.17in	6mm	0.24in	11.08	576
m0844	i0033	844mm	33.24in	833mm	32.81in	6mm	0.24in	11.67	607
m0886	i0035	886mm	34.88in	875mm	34.45in	6mm	0.24in	12.25	637
m0928	i0037	928mm	36.52in	917mm	36.09in	6mm	0.24in	12.83	667
m0969	i0038	969mm	38.16in	958mm	37.73in	6mm	0.24in	13.42	698
m1011	i0040	1011mm	39.80in	1000mm	39.37in	6mm	0.24in	14.00	728
m1053	i0041	1053mm	41.44in	1042mm	41.01in	6mm	0.24in	14.58	758
m1094	i0043	1094mm	43.08in	1083mm	42.65in	6mm	0.24in	15.17	789
m1136	i0045	1136mm	44.72in	1125mm	44.29in	6mm	0.24in	15.75	819
m1178	i0046	1178mm	46.36in	1167mm	45.93in	6mm	0.24in	16.33	849
m1219	i0048	1219mm	48.01in	1208mm	47.57in	6mm	0.24in	16.92	880
m1261	i0050	1261mm	49.65in	1250mm	49.21in	6mm	0.24in	17.50	910
m1303	i0051	1303mm	51.29in	1292mm	50.85in	6mm	0.24in	18.08	940
m1344	i0053	1344mm	52.93in	1333mm	52.49in	6mm	0.24in	18.67	971
m1386	i0055	1386mm	54.57in	1375mm	54.13in	6mm	0.24in	19.25	1001
m1428	i0056	1428mm	56.21in	1417mm	55.77in	6mm	0.24in	19.83	1031
m1469	i0058	1469mm	57.85in	1458mm	57.41in	6mm	0.24in	20.42	1062
m1511	i0059	1511mm	59.49in	1500mm	59.06in	6mm	0.24in	21.00	1092
m1553	i0061	1553mm	61.13in	1542mm	60.70in	6mm	0.24in	21.58	1122
m1594	i0063	1594mm	62.77in	1583mm	62.34in	6mm	0.24in	22.17	1153
m1636	i0064	1636mm	64.41in	1625mm	63.98in	6mm	0.24in	22.75	1183
m1678	i0066	1678mm	66.05in	1667mm	65.62in	6mm	0.24in	23.33	1213
m1719	i0068	1719mm	67.69in	1708mm	67.26in	6mm	0.24in	23.92	1244
m1761	i0069	1761mm	69.33in	1750mm	68.90in	6mm	0.24in	24.50	1274
m1803	i0071	1803mm	70.97in	1792mm	70.54in	6mm	0.24in	25.08	1304
m1844	i0073	1844mm	72.61in	1833mm	72.18in	6mm	0.24in	25.67	1335

LINI-S XL R014

Length Availability List



Length Code		Fixture Length ¹		LED Strip ²		End Cap Dimension ³		Wattage (W)	Output (lm)
Metric	Imperial(US)	Metric	Imperial(US)	Metric	Imperial(US)	Metric	Imperial(US)		3000K (Test Data)
m1886	i0074	1886mm	74.25in	1875mm	73.82in	6mm	0.24in	26.25	1365
m1928	i0076	1928mm	75.89in	1917mm	75.46in	6mm	0.24in	26.83	1395
m1969	i0078	1969mm	77.53in	1958mm	77.10in	6mm	0.24in	27.42	1426
m2011	i0079	2011mm	79.17in	2000mm	78.74in	6mm	0.24in	28.00	1456

¹ Actual total overall length of light fixture (LED strip + end caps + void/wire hole)

² Actual length of PCB strip

³ Actual length of 2x end caps

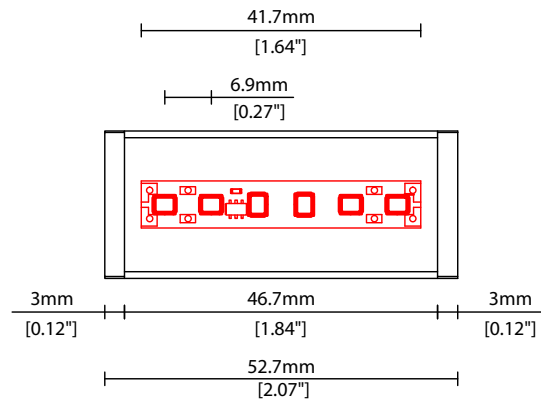

Linear

LINI-S XL R014

Options

KKDC

COVER/LENS OPTIONS

* Options are an integral part of the fixture ordering codes. Please refer to **Code Table** pages.

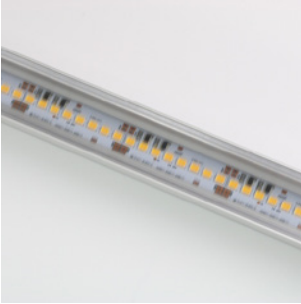

B Clear cover

W22/H27.9mm (W0.87/H1.10")

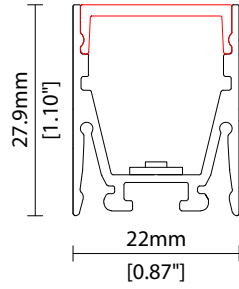

C Diffused cover

W22/H27.9mm (W0.87/H1.10")

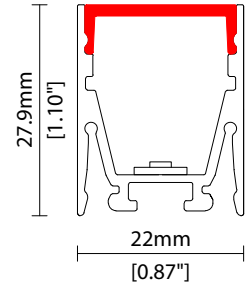

POWER FEED OPTIONS

0300 S00X 300mm (11.81") Single no sheath tail

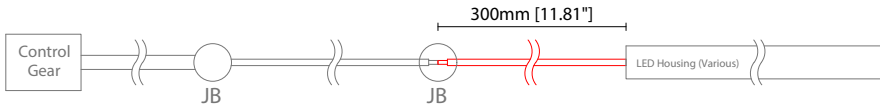

0300 D00X 300mm (11.81") Double no sheath tail

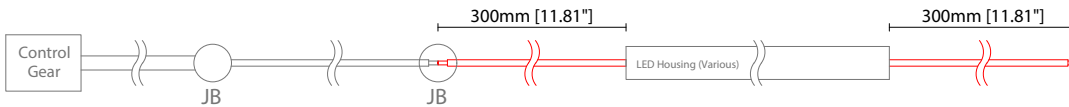

0300 S20X 300mm (11.81") Single no sheath IP20 connector

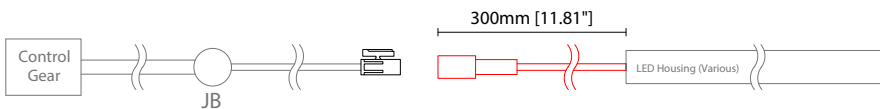

0300 D20X 300mm (11.81") Double no sheath IP20 connector

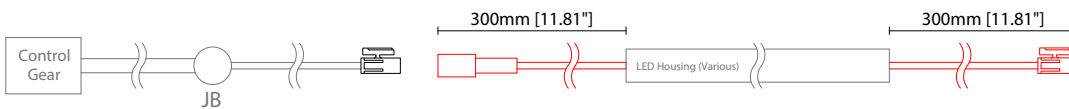

1000 S00X 1000mm (39.37") Single no sheath tail

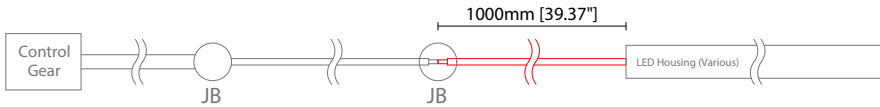

1000 D00X 1000mm (39.37") Double no sheath tail

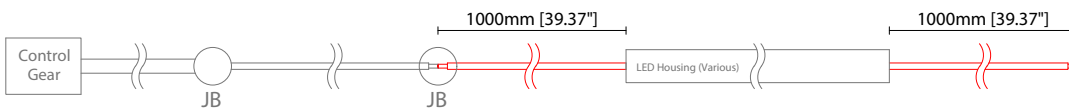

1000 S20X 1000mm (39.37") Single no sheath IP20 connector

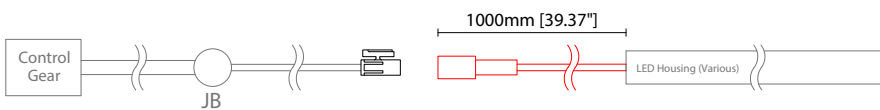

1000 D20X 1000mm (39.37") Double no sheath IP20 connector

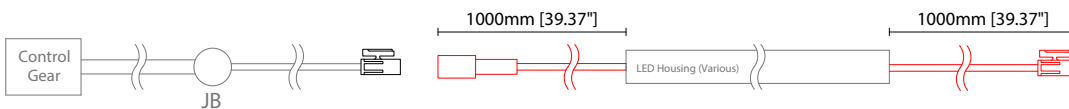

Key

Control Gear Power supply, sub-controllers & control systems
 JB Junction box / cable connection

POWER FEED OPTIONS (CONTINUED)

2 Pin Female Connector

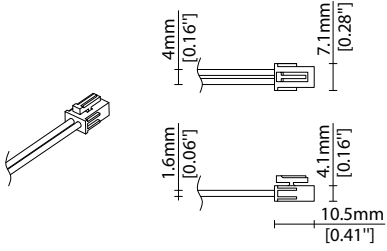

2 Pin Male Connector

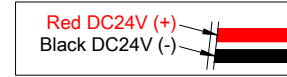
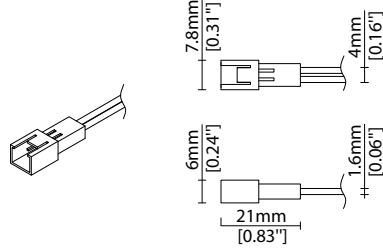

MOUNTING ACCESSORIES

Note: Accessories are to be ordered separately with corresponding code shown below.



KKCP-11

Concealed clip
(allow 3 per metre/40in)
S/Steel finish
L20/W22/H28.1mm
(L0.79/W0.87/H1.11")

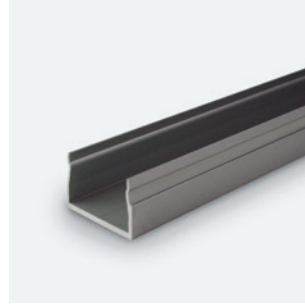
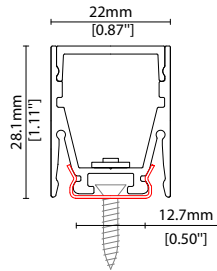

KKCR-01-1000 1000mm (39.37in)
KKCR-01-2000 2000mm (78.74in)
KKCR-01-3000 3000mm (118.11in)

Cable raceway*
anodised aluminium finish
W22/H36.4mm (W0.87/H1.43")

* Cut & drilled to fit on site

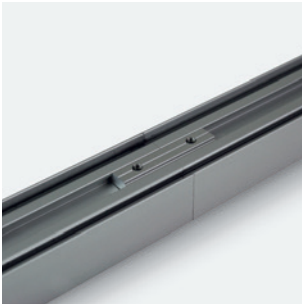
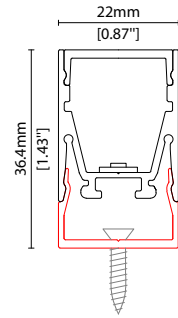

KKJT-02

Joining bar* (allow 1 per join)
anodised aluminium finish
L25mm (L0.98")

* Mounting option required with
Joining bar

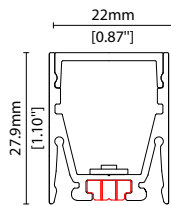

POWER FEED

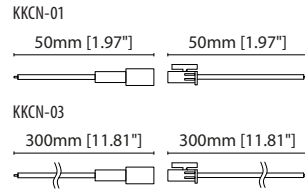
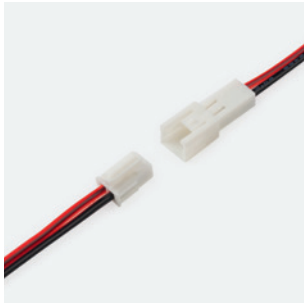

KKCN-01 50mm (1.97in) pair
KKCN-03 300mm (11.81in) pair
 2 PIN male + female connector set

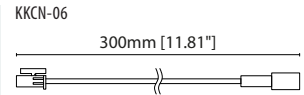

KKCN-06
 2 PIN 300mm (11.81in) extension lead

KKDC CONTROL



IP20
 Plastic housing
 L170/W59/H29mm
 (L6.69/W2.32/H1.14in)

KKDM-06 1-10V
 visDIM dimmable sub-controller
 (4 x 8A max @ 12-36V)



IP20
 Plastic housing
 L170/W53.4/H28mm
 (L6.69/W2.10/H1.10in)

KKSC-05 DMX
 visDIM dimmable sub-controller
 (4 x 5A max @ 12-36V)



IP20
 Plastic housing
 L170/W59/H29mm
 (L6.69/W2.32/H1.14in)

KKDL-02 DALI
 visDIM dimmable sub-controller
 (4 x 8A max @ 12-36V)



IP20
 Plastic housing
 L166/W53.4/H23mm
 (L6.54/W2.10/H0.91in)

KKDL-03 DALI
 visDIM dimmable sub-controller
 (4 x 5A max @ 12-36V)

AVAILABLE PSU OPTIONS

Control Mode	PSU (Order Code)	Input Voltage AC	Output Voltage DC	Rated Output Current	Rated Power	Dim %	IP Rating
Switched	CEN-60-24	90-295V	24V	2.5A	60W	-	IP67
	HLG-60H-24	90-305V	24V	2.5A	60W	-	IP67
	HLG-100H-24	90-305V	24V	4.0A	100W	-	IP67
	HLG-150H-24	90-305V	24V	6.3A	150W	-	IP67
	HLG-240H-24	90-305V	24V	10A	240W	-	IP67
0-10V (1-10V)	PWM-40-24	90-305V	24V	1.67A	40W	100-0.15 (100-10)	IP67
	PWM-60-24	90-305V	24V	2.5A	60W	100-0.15 (100-10)	IP67
	PWM-90-24	90-305V	24V	3.67A	90W	100-0.15 (100-10)	IP67
	PWM-120-24	90-305V	24V	5.0A	120W	100-0.15 (100-10)	IP67
DALI	LIN100A1	120-277V	24V	1A per channel	100W	100-0.1	IP66/IP40
DMX RGB	LIN100A1	120-277V	24V	1.33A per channel	100W	100-0.1	IP66/IP40
DMX RGBW	LIN100A1	120-277A	24V	1A per channel	100W	100-0.1	IP66/IP40

Flicker Free Options - Combination of PSU+ sub-controller

Control Mode	PSU (Order Code)	Sub-controller (Order Code)	Input Voltage AC	Output Voltage DC	Rated Output Current	Rated Power	Dim %	IP Rating PSU/ Sub-controller
0-10V or 1-10V	CEN-60-24	KKDM-06	90-295V	24V	2.5A	60W	100-0.9	IP67/IP20
	HLG-60H-24	KKDM-06	90-295V	24V	2.5A	60W	100-0.9	IP67/IP20
	HLG-100H-24	KKDM-06	90-295V	24V	4.0A	100W	100-0.9	IP67/IP20
	HLG-150H-24	KKDM-06	90-295V	24V	6.3A	150W	100-0.9	IP67/IP20
	HLG-240H-24	KKDM-06	90-295V	24V	10.0A	240W	100-0.9	IP67/IP20
DALI	CEN-60-24	KKDL-02/03	90-295V	24V	2.5A	60W	100-0.1	IP67/IP20
	HLG-60H-24	KKDL-02/03	90-305V	24V	2.5A	60W	100-0.1	IP67/IP20
	HLG-100H-24	KKDL-02/03	90-305V	24V	4.0A	100W	100-0.1	IP67/IP20
	HLG-150H-24	KKDL-02/03	90-305V	24V	6.3A	150W	100-0.1	IP67/IP20
	HLG-240H-24	KKDL-02/03	90-305V	24V	10.0A	240W	100-0.1	IP67/IP20
DMX RGB	CEN-60-24	KKSC-05	90-295V	24V	2.5A	60W	100-0.9	IP67/IP20
	HLG-60H-24	KKSC-05	90-305V	24V	2.5A	60W	100-0.9	IP67/IP20
	HLG-100H-24	KKSC-05	90-305V	24V	4A	100W	100-0.9	IP67/IP20
	HLG-150H-24	KKSC-05	90-305V	24V	6.3A	150W	100-0.9	IP67/IP20
	HLG-240H-24	KKSC-05	90-305V	24V	10.0A	240W	100-0.9	IP67/IP20

¹ The items shown above cover the most frequently used specification but does not exhaust the possible options

² PSU and/or driver can be chosen from the table, or KKDC may recommend the best option upon receipt of the controls requirement and installation environment

³ Electrical shop drawing will include detailed information of PSU and relevant control drivers

⁴ Cut sheets are available on the controls section of www.kkdc.lighting or upon request